

# Making corrections to your proof

Please follow these instructions to mark changes or add notes to your proof. You can use Adobe Acrobat Reader (download the most recent version from <https://get.adobe.com>) or an open source PDF annotator.

For Adobe Reader, the tools you need to use are contained in **Annotations** in the **Comment** toolbar. You can also right-click on the text for several options. The most useful tools have been highlighted here. If you cannot make the desired change with the tools, please insert a sticky note describing the correction.

Please ensure all changes are visible via the 'Comments List' in the annotated PDF so that your corrections are not missed.

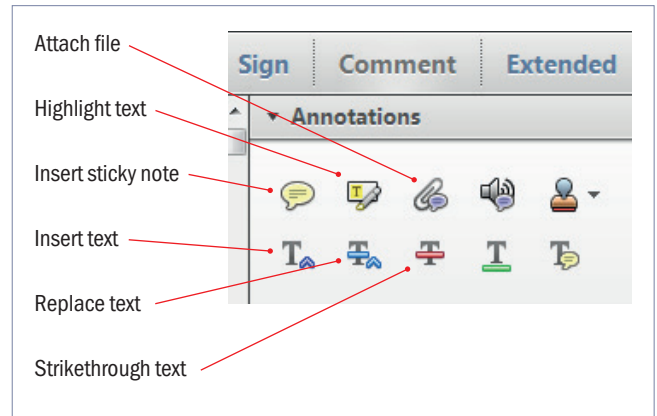

**Do not attempt to directly edit the PDF file as changes will not be visible.**



## Replacing text

To replace text, highlight what you want to change then press the replace text icon, or right-click and press 'Add Note to Replace Text', then insert your text in the pop up box. Highlight the text and right click to style in bold, italic, superscript or subscript.

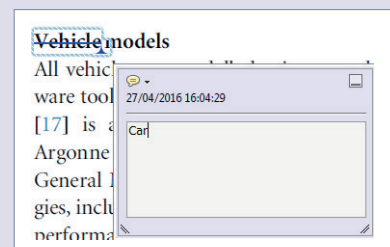

## Inserting text

Place your cursor where you want to insert text, then press the insert text icon, or right-click and press 'Insert Text at Cursor', then insert your text in the pop up box. Highlight the text and right click to style in bold, italic, superscript or subscript.

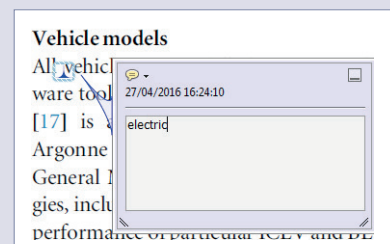

## Deleting text

To delete text, highlight what you want to remove then press the strikethrough icon, or right-click and press 'Strikethrough Text'.

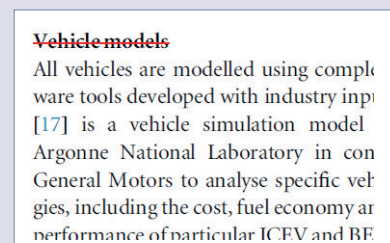

## Highlighting text

To highlight text, with the cursor highlight the selected text then press the highlight text icon, or right-click and press 'Highlight text'. If you double click on this highlighted text you can add a comment.

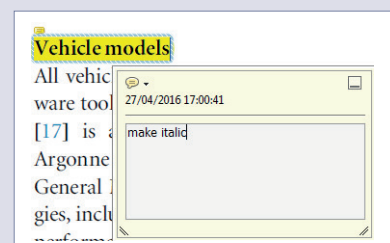

# QUERY FORM

JOURNAL: New Journal of Physics

AUTHOR: M Steiner *et al*



TITLE: Transmission spectroscopy of a single atom in the presence of tensor light shifts

ARTICLE ID: njpab0431

---

---

The layout of this article has not yet been finalized. Therefore this proof may contain columns that are not fully balanced/matched or overlapping text in inline equations; these issues will be resolved once the final corrections have been incorporated.

Please check that  **names of all authors as displayed in the proof are correct**, and that all **authors are linked to the correct affiliations**. Please also confirm that the correct corresponding author has been indicated. **Note that this is your last opportunity to review and amend this information before your article is published.** 

If an explicit acknowledgment of funding is required, please ensure that it is indicated in your article. If you already have an Acknowledgments section, please check that the information there is complete and correct.

---

Please check that the funding information below is correct for inclusion in the article metadata.



National Research Foundation Singapore; Ministry of Education - Singapore; Lee Kuan Yew Postdoctoral Fellowship. 

---

## Page 7

---

Q1

Please check the details for any journal references that do not have a link as they may contain some incorrect information. If  journal references do not have a link, please update with correct details and supply a Crossref DOI if available. 

---

## Page 7

---

Q2

Please provide updated details for reference [12, 19] if available. 

---

**PAPER****Transmission spectroscopy of a single atom in the presence of tensor light shifts****OPEN ACCESS****RECEIVED**  
16 August 2018**REVISED**  
10 January 2019**ACCEPTED FOR PUBLICATION**  
4 February 2019**PUBLISHED**  
DD MM 2019**Matthias Steiner<sup>1,2</sup>, Yue-Sum Chin<sup>1</sup> and Christian Kurtsiefer<sup>1,2</sup>**<sup>1</sup> Centre for Quantum Technologies, 3 Science Drive 2, 117543, Singapore<sup>2</sup> Department of Physics, National University of Singapore, 2 Science Drive 3, 117542, Singapore**E-mail:** [christian.kurtsiefer@gmail.com](mailto:christian.kurtsiefer@gmail.com)**Keywords:** single atom dipole trap, tensor light shift, neutral atom qubitOriginal content from this work may be used under the terms of the [Creative Commons Attribution 3.0 licence](https://creativecommons.org/licenses/by/4.0/).

Any further distribution of this work must maintain attribution to the author(s) and the title of the work, journal citation and DOI.

**Abstract**

We investigate the interplay between Zeeman and light shifts in the transmission spectrum of an optically trapped, spin-polarized Rubidium atom. The spectral shape of the transmission changes from multiple, broad resonances to a single, narrow Lorentzian with a high resonant extinction value when we increase the magnetic field strength and lower the depth of the dipole trap. We present an experimental configuration well-suited for quantum information applications that enables not only efficient light-atom coupling, but also a long coherence time between ground state hyperfine levels.

**1. Introduction**

Optically trapped, individually addressable neutral atoms have been established as a viable platform for advanced applications in quantum information science [1, 2]. In this approach, a qubit is typically realized by two ground state hyperfine levels of the atom. Several strategies have been developed to connect multiple atomic qubits. For example, nearby atoms can interact by optical coupling to highly excited Rydberg states [3]. Alternatively, atoms separated by large distances can be connected through an optical link and the exchange of single photons [4].

While deep optical tweezers are a versatile and convenient tool to prepare [5], move [6], and hold [7] individual atoms, the trapping field can also have undesired consequences like shortened qubit coherence times. Thus the sensitivity of the qubit coherence to light shifts has been extensively investigated for various experimental configurations [8–12], including very tightly focused optical tweezers [13, 14]. Little explored are light shift induced effects on optical transitions beyond line shifts [15]; an example is the optically induced breakdown of the atomic hyperfine coupling [16].

In this article we investigate both the optical and qubit coherence properties of a <sup>87</sup>Rb atom in a deep optical trap. We are particularly interested in realizing a ground state qubit with qubit-selective, closed optical transitions that are efficiently coupled to a propagating mode. Such a system can potentially be used to sequentially produce large numbers of entangled photons [17–19]. Efficient light-atom coupling is achieved by trapping individual atoms in optical tweezers and placing them at the focus of a high numerical aperture lens for a probe mode. In previous work, we used such an arrangement to realize strong extinction of a coherent beam by a single atom [20, 21], and to resolve scattering dynamics for various temporal profiles of the incident light [22–24]. Here, we show that conditions for efficient light-atom interaction, i.e. strong extinction, are compatible with a long qubit coherence time. In contrast to our earlier experiments [20–24], we use a linearly polarized dipole trap, which strongly reduces atomic motion-induced qubit dephasing, but affects the light-atom coupling through a tensor light shift. We perform transmission spectroscopy to investigate the impact of the tensor light shift on the optical coupling in detail.

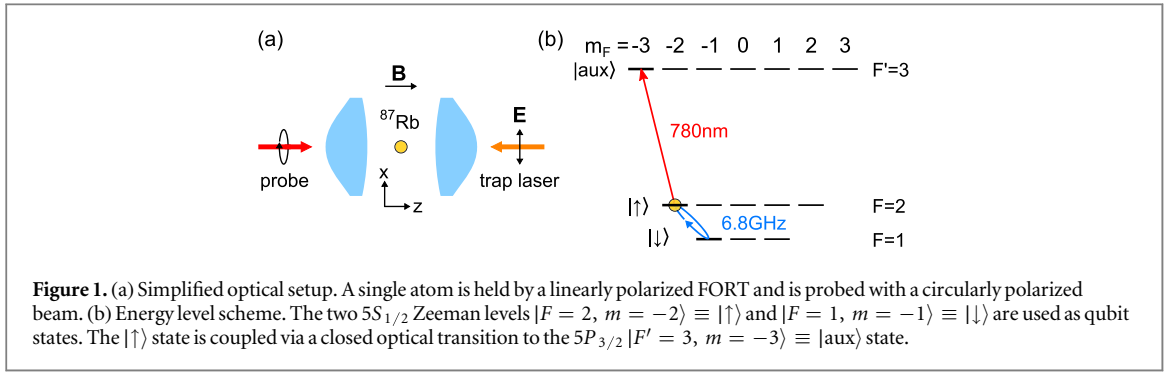

**Figure 1.** (a) Simplified optical setup. A single atom is held by a linearly polarized FORT and is probed with a circularly polarized beam. (b) Energy level scheme. The two  $5S_{1/2}$  Zeeman levels  $|F = 2, m = -2\rangle \equiv |\uparrow\rangle$  and  $|F = 1, m = -1\rangle \equiv |\downarrow\rangle$  are used as qubit states. The  $|\uparrow\rangle$  state is coupled via a closed optical transition to the  $5P_{3/2}$   $|F' = 3, m = -3\rangle \equiv |\text{aux}\rangle$  state.

## 2. Zeeman and light shift Hamiltonian

We consider an optically trapped  $^{87}\text{Rb}$  atom in a magnetic field applied along the quantization axis ( $z$ -axis, see figure 1(a)). The magnetic field lifts the degeneracy of the Zeeman levels with the corresponding Hamiltonian  $\hat{H}_{B,F}$  for the hyperfine manifold  $F$

$$\hat{H}_{B,F} = \hbar\omega_L \hat{F}_z, \quad (1)$$

where  $\omega_L$  is the Larmor frequency, and  $\hat{F}_z$  the  $z$ -component of the total angular momentum operator  $\hat{\mathbf{F}}$  of the respective hyperfine level. We use the two  $5S_{1/2}$  Zeeman levels,  $|F = 2, m = -2\rangle \equiv |\uparrow\rangle$  and  $|F = 1, m = -1\rangle \equiv |\downarrow\rangle$ , as qubit states (figure 1(b)). The choice of these states over the commonly used clock states  $|F = 2, m = 0\rangle$  and  $|F = 1, m = 0\rangle$  is motivated by the possibility to couple  $|\uparrow\rangle$  via a closed optical transition to the  $5P_{3/2}$   $|F' = 3, m = -3\rangle \equiv |\text{aux}\rangle$  state.

The energy levels are further shifted by the light shift induced by the trapping field. For each hyperfine manifold, the light shift Hamiltonian  $\hat{H}_{\text{ls},F}$  can be decomposed into a scalar, a vector, and a tensor term

$$\hat{H}_{\text{ls},F} = U_0(c_s + c_v(\epsilon^* \times \epsilon) \cdot \hat{\mathbf{F}} + c_t |\epsilon \cdot \hat{\mathbf{F}}|^2), \quad (2)$$

where  $U_0$  is the trap depth,  $\epsilon$  is the polarization vector of the trapping field, and  $c_s$ ,  $c_v$ , and  $c_t$  are the coefficients of the scalar, vector, and tensor light shifts [25].

The qubit coherence is greatly affected when the trapping field causes a frequency shift  $\delta$  of the  $|\uparrow\rangle$  to  $|\downarrow\rangle$  transition. Then the qubit frequency changes as the atom oscillates in the trap, which leads to dephasing on a timescale of  $T_2^* \approx U_0 / (\delta\pi k_B T_{\text{atom}})$ , where  $T_{\text{atom}}$  is the temperature of the atom and  $k_B$  the Boltzmann constant [26]. In a far off-resonant dipole trap (FORT), the contribution of the scalar and the tensor term to the shift  $\delta$  is negligible ( $c_s$  is the same for the two ground state hyperfine manifolds  $5S_{1/2}$   $F = 1, 2$  and  $c_t \approx 0$ ). The vector light shift, however, leads to rapid dephasing. For example, a 1mK-deep, circularly polarized trap at 851 nm shifts the qubit frequency by  $\delta = 2.6$  MHz; for a typical atom temperature of 50  $\mu\text{K}$ , the corresponding dephasing time  $T_2^* \approx 2$   $\mu\text{s}$  is prohibitively short for quantum information purposes. Therefore, we use a FORT linearly polarized along the  $x$ -axis, for which the vector shift vanishes ( $\epsilon^* \times \epsilon = 0$ ). Notably for very tightly focused beams, even a linearly polarized FORT results in a spatially varying vector light shift and rapid qubit dephasing (as observed in [14]). For our focusing strength, detuning and beam intensity, however, this nonparaxial focus effect is negligible (see section 4).

In this configuration the light-shift Hamiltonian for the excited state hyperfine manifold  $5P_{3/2}$   $F' = 3$  reads

$$\hat{H}_{\text{ls},F'=3} = U_0(c_s + c_t F_x^2), \quad (3)$$

with  $c_s = 0.7417$  and  $c_t = -0.0716$  for a FORT operating at 851 nm. The nonlinear term proportional to  $F_x^2$  leads to energy eigenstates that are superpositions of either even or odd  $m_z$  states. Consequently, the absorption spectrum and, in particular, the optical coupling between  $|\uparrow\rangle$  and  $|\text{aux}\rangle$  depend strongly on the relative strength of Zeeman and light shift.

## 3. Transmission experiment

To determine the impact of the light shift on the optical coupling, we perform transmission spectroscopy on a single  $^{87}\text{Rb}$  atom in a tightly focused red-detuned FORT [5]. The atom is held between two high numerical aperture lenses (NA = 0.75, focal length  $f = 5.95$  mm) with a 2.24 mK-deep FORT operating at a wavelength 851 nm [21, 27]. The trapping beam is linearly polarized (with a polarization extinction ratio  $\approx 34$  dB [28]) and

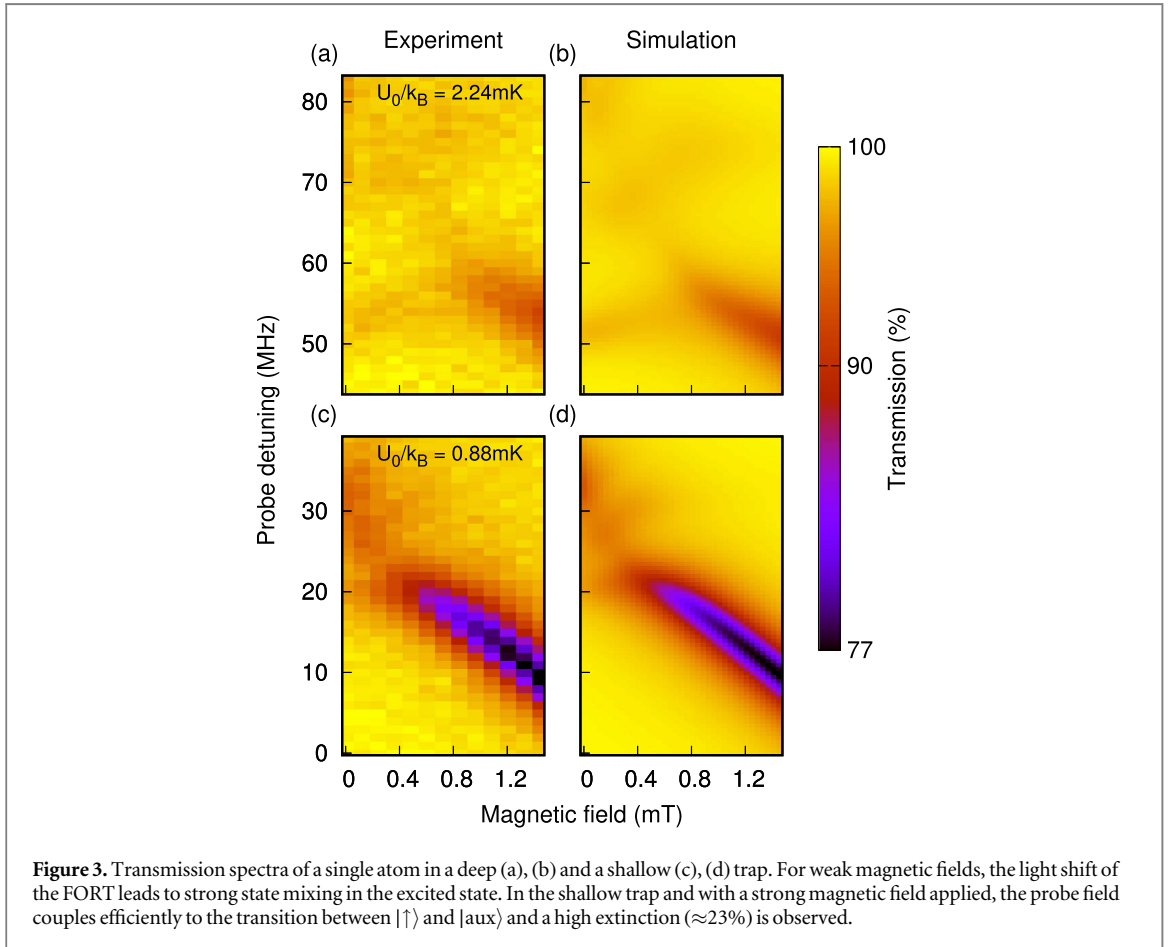
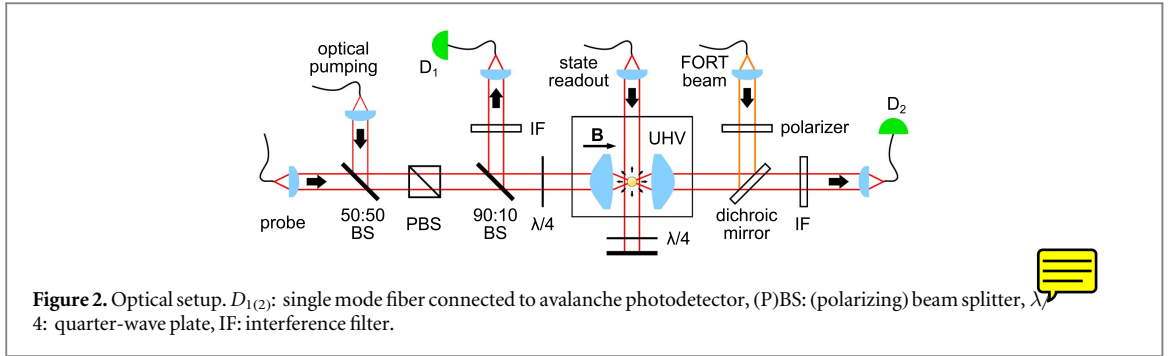

focused to a waist  $w_0 \approx 1.4 \mu\text{m}$ . Part of the atomic fluorescence is collected by the same lenses and coupled to single mode fibers connected to avalanche photodetectors,  $D_1$  and  $D_2$  (figure 2).

After loading an atom into the FORT, we cool the atom to  $16.4(6) \mu\text{K}$  by 10 ms of polarization gradient cooling [28]. Then, a bias magnetic field is applied along the quantization axis ( $z$ -axis), and the atom is optically pumped into  $|\uparrow\rangle$ . We probe the light-atom interaction with a circularly polarized ( $\sigma^-$ ) beam, driving the transition  $|\uparrow\rangle$  to  $|\text{aux}\rangle$  near 780 nm. The Rabi frequency of the driving field  $\Omega = 0.052(3)\Gamma$  is set far below saturation ( $\Gamma = 2\pi \times 6.07 \text{ MHz}$  is the spontaneous decay rate). During the 1 ms long probe pulse, we accumulate the number of detected photons  $n_p$  at the detector  $D_2$ . We then obtain the transmission  $T = n_p/n_0$  by comparing  $n_p$  to the number  $n_0$  of detected photons in a reference measurement during which the atom is in a state off-resonant with the probe field ( $F = 1$ ).

Figure 3(a) shows the observed transmission spectrum as we vary the frequency of the probe field and the amplitude of the bias magnetic field. We observe a peak extinction of  $\epsilon = 1 - T = 8.2(3)\%$  for the largest magnetic field applied (1.44 mT). As the magnetic field strength is reduced, the spectrum shows a lower peak extinction and multiple, broad resonances. This is in stark contrast to the strong extinction ( $\approx 22\%$ ) we observed in our previous experiments with the same optical setup with a circularly polarized FORT [21]. We then repeat

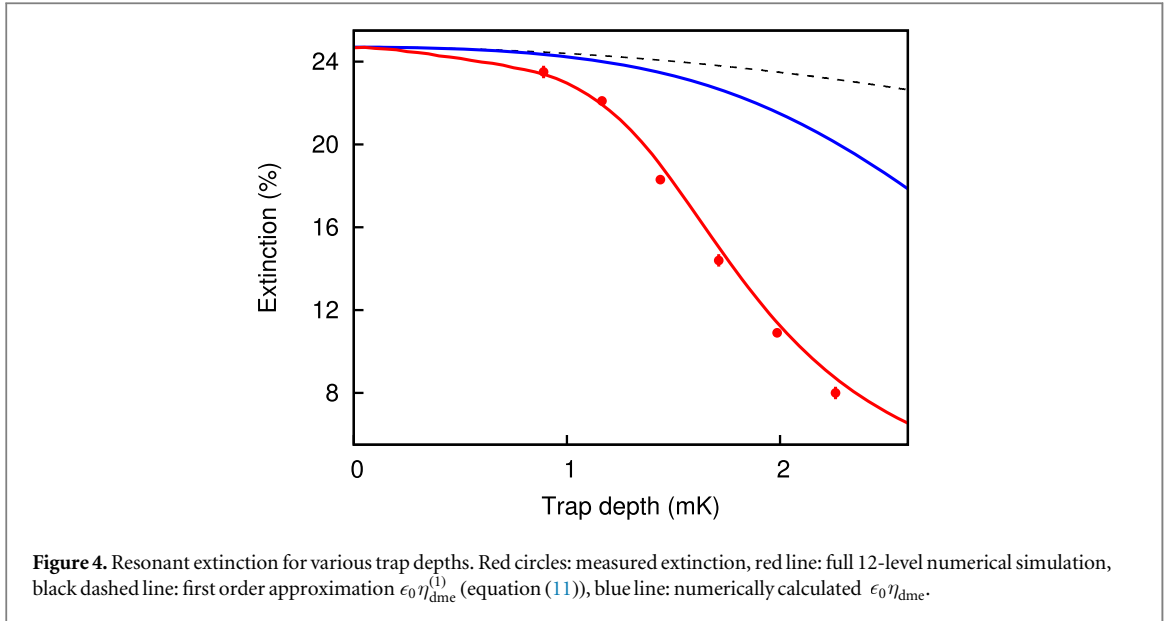

the experiment, but this time, after polarization gradient cooling, we lower the trap depth to 0.88 mK. This increases the observed extinction significantly (figure 3(c)). For our largest magnetic field the transmission spectrum consists of a single Lorentzian line with high peak extinction  $\epsilon = 23.3(3)\%$ .

To better understand the effect of the tensor light shift on the transmission spectrum, we numerically calculate the dynamics for the 12-level system containing the  $F = 2$  and  $F' = 3$  manifolds. Aside from the Zeeman and light shifts (equations (1)–(3)), we include a term in the Hamiltonian that describes the interaction with the  $\sigma^-$ -polarized probe light detuned from the natural  $F = 2$  to  $F' = 3$  transition frequency  $\omega_0$  by  $\Delta = \omega_p - \omega_0$

$$\hat{H}_{\text{int}} = -\frac{\hbar}{2}\Omega\hat{A}_- + \text{h.c.}, \quad (4)$$

where  $\hat{A}_-$  is the atomic lowering operator. For the total Hamiltonian

$$\begin{aligned} \hat{H} = & \hat{H}_0 + \hat{H}_{B,F=2} + \hat{H}_{B,F'=3} \\ & + \hat{H}_{\text{ls},F=2} + \hat{H}_{\text{ls},F'=3} + \hat{H}_{\text{int}}, \end{aligned} \quad (5)$$

with  $\hat{H}_0 = -\Delta\mathbb{1}_{F=2}$ , where  $\mathbb{1}_{F=2}$  is the unity operator acting on the  $F = 2$  manifold, we numerically solve the corresponding master equation

$$\dot{\rho} = -\frac{i}{\hbar}[\rho, \hat{H}] + \mathcal{L}[\rho], \quad (6)$$

with a Lindblad superoperator  $\mathcal{L}[\rho]$  to account for spontaneous emission.

We initialize in  $|\uparrow\rangle$  and apply the probe field for a time  $\tau = 1 \text{ ms} \gg 1/\Omega \gg 1/\Gamma$ . Comparing the number of scattered photons during the probe phase

$$n_p(\Delta) = \int_0^\tau \text{Tr}(\rho(t)P_{F'=3})\Gamma dt, \quad (7)$$

with the value expected for a resonantly driven two-level system

$$n_{2l} = \frac{\Omega^2}{\Gamma^2 + 2\Omega^2}\Gamma\tau \approx 100, \quad (8)$$

we obtain an expected reduction  $\eta = n_p(\Delta)/n_{2l}$  of the absorption. Here,  $P_{F'=3}$  is the projector onto the  $F' = 3$  manifold. The estimated transmission as a function of probe detuning is then

$$T(\Delta) = 1 - \epsilon_0\eta(\Delta), \quad (9)$$

where  $\epsilon_0$  is the resonant, two-level extinction value which depends on the spatial mode of the probe fields.

We find an excellent agreement between the observed spectrum  $T(\Delta)$  and the model for  $\epsilon_0 = 24.7\%$ , a value consistent with our previous experiment [21] (figures 3(b), (d)). We further test our model by comparing the resonant extinction at various trap depths, but a fixed magnetic field strength of 1.44 mT (figure 4). Again, the model matches the experimental data well. To further understand the scattering process, we consider the relevant dipole matrix element: for a vanishing light shift, both  $|\uparrow\rangle$  and  $|\text{aux}\rangle$  are energy eigenstates. The



$\sigma^-$ -polarized probe beam couples these two states with a dipole matrix element  $|\langle \uparrow | \epsilon_{\sigma^-} \hat{\mathbf{d}} | \text{aux} \rangle|^2$ , where  $\epsilon_{\sigma^-}$  is the polarization vector of the probe beam,  $\hat{\mathbf{d}}$  is the electric dipole operator. With increasing transverse tensor shift [equation (3)], the angular momentum eigenstate  $|\text{aux}\rangle$  is no longer an energy eigenstate—the corresponding eigenstate  $|\widehat{\text{aux}}\rangle$  of equation (5) gets admixtures from other  $m_z$ -states of the same level. Thus, the optical coupling strength is reduced by the relative reduction of the dipole matrix element

$$\eta_{\text{dme}} = \frac{|\langle \uparrow | \epsilon_{\sigma^-} \hat{\mathbf{d}} | \widehat{\text{aux}} \rangle|^2}{|\langle \uparrow | \epsilon_{\sigma^-} \hat{\mathbf{d}} | \text{aux} \rangle|^2}. \quad (10)$$

For strong magnetic fields,  $\hbar\omega_L \gg U_0 c_t$ , the reduction of the dipole matrix element in first order approximation is given by

$$\eta_{\text{dme}}^{(1)} = 1 - \frac{15}{8} \left( \frac{U_0 c_t}{\hbar\omega_L} \right)^2. \quad (11)$$

However, neither  $\epsilon_0 \eta_{\text{dme}}^{(1)}$  nor the numerically calculated  $\epsilon_0 \eta_{\text{dme}}$  reproduces our measured values well (figure 4). The reason is that the observed spectrum is strongly affected by multiple scattering events. When the energy eigenstates are superpositions of  $m_z$  states, there is a probability that a scattering event brings the atom out of the  $\{|\uparrow\rangle, |\text{aux}\rangle\}$  subspace. After such an optical depolarization event, the resonance frequency is shifted, and thus the optical coupling is strongly reduced. The full numerical simulation takes these spin flips into account, resulting in a good match with the experimental data.

From the comparison between experiment and theory we learn that (I) it is indeed the tensor light shift that causes the complexity of the transmission spectrum, (II) the spin dynamics induced by multiple scattering events are important for the spectral shape of the spectrum, and (III) the optical coupling between  $|\uparrow\rangle$  and  $|\text{aux}\rangle$  is close to an ideal two-level system in a shallow trap with a strong magnetic field applied.

## 4. Ground state qubit

We characterize the ground state qubit in terms of state readout fidelity and coherence time to show that efficient optical coupling and a long coherence time of the qubit can be simultaneously achieved. For the following experiments, we choose a trap depth  $U_0 = k_B \times 0.88$  mK and a magnetic field strength of 1.44 mT, in which the highest optical coupling is observed.

Our state readout method is based on state-selective fluorescence detection [29, 30]: we illuminate the atom for 600  $\mu\text{s}$  with light that is resonant with the  $5S_{1/2} F = 2$  to  $5P_{3/2} F' = 3$  transition and infer the qubit state from the number of photons registered at photodetectors  $D_1$  and  $D_2$ . The circularly polarized state detection beam propagates perpendicular to the quantization axis and is back reflected with opposite circular polarization (figure 2).

The readout fidelity is determined by preparing the atom in a particular state, and then performing the state readout. When the atom is initially in  $|\uparrow\rangle$ , we detect a mean number of  $n_{\uparrow} = 9.85(8)$  photons. For an atom in  $|\downarrow\rangle$ , the atom ideally scatters almost no photons because of the large hyperfine splitting of 6.8 GHz; we occasionally register one or two detection events (mean number of  $n_{\downarrow} = 0.17(1)$  photons). For this measurement, we indiscriminately prepare the atom in the  $5S_{1/2} F = 1$  as the same dark state behavior is expected for all three Zeeman levels.

Figure 5(a) shows the histogram of  $n_{\uparrow}$  and  $n_{\downarrow}$  after 3000 repetitions of the experiment, from which we determine a threshold value  $n_{\text{th}} = 2$  that optimizes the discrimination between the two distributions. The probabilities for erroneous state assignment are  $\chi_{\uparrow} = 1.5\%$  and  $\chi_{\downarrow} = 1.4\%$  for an atom prepared in  $|\uparrow\rangle$  and  $|\downarrow\rangle$ , respectively. Thus, we achieve a state readout fidelity  $F = 1 - (\chi_{\uparrow} + \chi_{\downarrow})/2 = 98.6(2)\%$ , similar to previously reported values [29–32].

To characterize the qubit coherence properties, we apply a microwave field resonant with the  $|\uparrow\rangle$  to  $|\downarrow\rangle$  transition to drive Rabi oscillations, and perform Ramsey and spin-echo sequences [8, 9, 33–35]. We observe a Rabi frequency of  $\Omega_{\text{mw}} = 2\pi \times 39.6(5)$  kHz with a visibility of 0.89(1) and little damping in the first 60  $\mu\text{s}$  [figure 5(b)]. The dephasing time is determined from a Ramsey experiment, where we apply two resonant microwave pulses for  $t_{\pi/2} = \pi/(2\Omega)$  separated by a free evolution time  $\tau$  [figure 5(c)]. We fit an exponential decay to the Ramsey contrast from which we extract the dephasing time  $T_2^* = 38(3)$   $\mu\text{s}$ , slightly shorter than reported in [14, 35]. We note that the dephasing time is not limited by the polarization gradients of the tightly focused FORT but other noise sources—following [14], we estimate that the polarization-gradient induced dephasing rate is 100 times lower than the observed value.

Applying a spin-echo, i.e. inserting an extra microwave pulse for  $t_{\pi} = \pi/\Omega$  halfway in the free evolution period  $\tau$ , reverses the inhomogeneous dephasing, and we observe a much slower decay of the contrast. Fitting to a heuristically chosen decaying Gaussian, we obtain the coherence time  $T_2 = 446(14)$   $\mu\text{s}$  defined as the  $1/e$

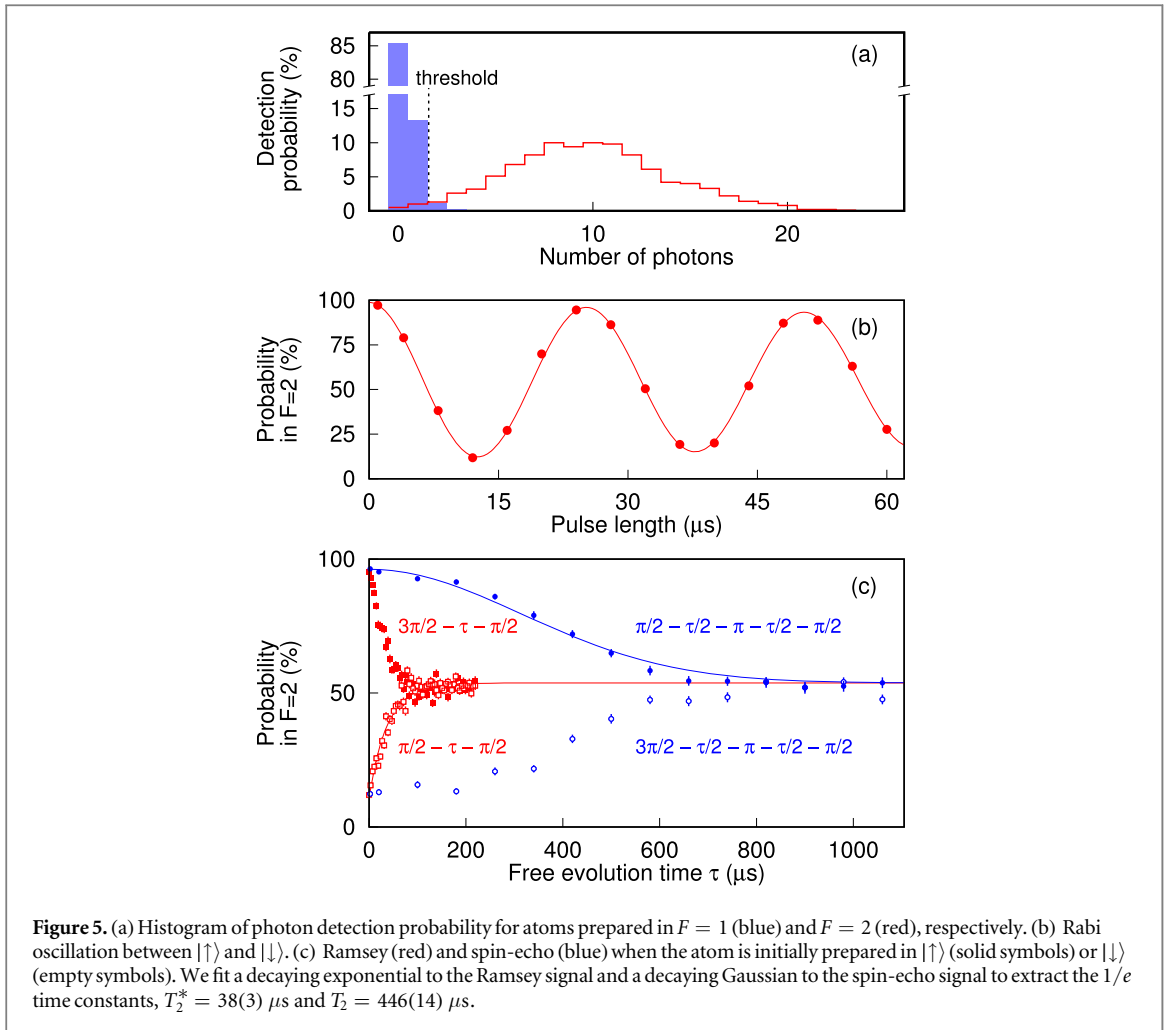

decay time of the spin-echo visibility. Despite not using the clock states, we achieve a high ratio of state manipulation speed and preserved coherence,  $T_2/t_\pi \approx 35$ . The Rabi frequency can be further increased by using fast optical Raman transitions [36, 37]. Figure 5(c) also displays the results of Ramsey and spin-echo experiments where we initially prepare the atom in state  $|\downarrow\rangle$ . As expected, the observed values mirror the experiments starting from  $|\uparrow\rangle$ .

## 5. Conclusion

We have shown that a combination of a shallow optical trap and strong magnetic fields sufficiently mitigates the effects of the tensor light shift on the optical coupling. Under these conditions, we demonstrated high qubit coherence and readout fidelity. The capability of coupling qubit states selectively to well-defined optical channels enables new ways of building up hybrid light-atom quantum states. In particular, we expect that several protocols that were originally developed for solid state quantum systems—where qubit state-selective, closed optical transitions are common—can be realized with a neutral atom in a dipole trap. This includes the generation of time-bin atom–photon entanglement [19] and the sequential generation of entangled photons [17, 18].

## Acknowledgments

We acknowledge the support of this work by the Ministry of Education in Singapore (AcRF Tier 1) and the National Research Foundation, Prime Minister’s office. M Steiner acknowledges support by the Lee Kuan Yew Postdoctoral Fellowship.



Q1

## References

- [1] Bernien H et al 2017 *Nature* **551** 579
- [2] Lienhard V, de Léséleuc S, Barredo D, Lahaye T, Browaeys A, Schuler M, Henry L-P and Läuchli A M 2018 *Phys. Rev. X* **8** 021070
- [3] Wilk T, Gaëtan A, Evellin C, Wolters J, Miroshnychenko Y, Grangier P and Browaeys A 2010 *Phys. Rev. Lett.* **104** 010502
- [4] Ritter S, Nölleke C, Hahn C, Reiserer A, Neuzner A, Uphoff M, Mücke M, Figueroa E, Bochmann J and Rempe G 2012 *Nature* **484** 195
- [5] Schlosser N, Reymond G, Protsenko I and Grangier P 2001 *Nature* **411** 1024
- [6] Endres M, Bernien H, Keesling A, Levine H, Anschuetz E R, Krajenbrink A, Senko C, Vuletić V, Greiner M and Lukin M D 2016 *Science* **354** 1024
- [7] Nogrette F, Labuhn H, Ravets S, Barredo D, Béguin L, Vernier A, Lahaye T and Browaeys A 2014 *Phys. Rev. X* **4** 021034
- [8] Kuhr S, Alt W, Schrader D, Dotsenko I, Miroshnychenko Y, Rosenfeld W, Khudaverdyan M, Gomer V, Rauschenbeutel A and Meschede D 2003 *Phys. Rev. Lett.* **91** 213002
- [9] Kuhr S, Alt W, Schrader D, Dotsenko I, Miroshnychenko Y, Rauschenbeutel A and Meschede D 2005 *Phys. Rev. A* **72** 023406
- [10] Kim H, Han H S and Cho D 2013 *Phys. Rev. Lett.* **111** 243004
- [11] Hutzler N R, Liu L R, Yu Y and Ni K-K 2017 *New J. Phys.* **19** 023007
- [12] Chalopin T, Bouazza C, Evrard A, Makhalov V, Dreon D, Dalibard J, Sidorenkov L A and Nascimbene S 2018 *arXiv:1806.05495* [quant-ph]
- [13] Kaufman A M, Lester B J and Regal C A 2012 *Phys. Rev. X* **2** 041014
- [14] Thompson J D, Tiecke T G, Zibrov A S, Vuletić V and Lukin M D 2013 *Phys. Rev. Lett.* **110** 133001
- [15] Shih C-Y and Chaman M S 2013 *Phys. Rev. A* **87** 063408
- [16] Neuzner A, Körber M, Dürr S, Rempe G and Ritter S 2015 *Phys. Rev. A* **92** 053842
- [17] Lindner N H and Rudolph T 2009 *Phys. Rev. Lett.* **103** 113602
- [18] Schwartz I, Cogan D, Schmidgall E R, Don Y, Gantz L, Kenneth O, Lindner N H and Gershoni D 2016 *Science* **354** 434
- [19] Lee J P, Villa B, Bennett A J, Stevenson R M, Ellis D J P, Farrer I, Ritchie D A and Shields A J 2018 *arXiv:1804.11311* [cond-mat.str-el]
- [20] Tey M K, Chen Z, Aljunid S A, Chng B, Huber F, Maslennikov G and Kurtsiefer C 2008 *Nat. Phys.* **4** 924
- [21] Chin Y-S, Steiner M and Kurtsiefer C 2017 *Nat. Commun.* **8** 1200
- [22] Aljunid S A, Maslennikov G, Wang Y, Dao H L, Scarani V and Kurtsiefer C 2013 *Phys. Rev. Lett.* **111** 103001
- [23] Leong V, Seidler M A, Steiner M, Cerè A and Kurtsiefer C 2016 *Nat. Commun.* **7** 13716
- [24] Steiner M, Leong V, Seidler M A, Cerè A and Kurtsiefer C 2017 *Opt. Express* **25** 6294
- [25] Deutsch I H and Jessen P S 2010 *Opt. Commun.* **283** 681
- [26] Romalis M V and Fortson E N 1999 *Phys. Rev. A* **59** 4547
- [27] Chin Y-S, Steiner M and Kurtsiefer C 2017 *Phys. Rev. A* **95** 043809
- [28] Chin Y-S, Steiner M and Kurtsiefer C 2017 *Phys. Rev. A* **96** 033406
- [29] Fuhrmanek A, Bourgain R, Sortais Y R P and Browaeys A 2011 *Phys. Rev. Lett.* **106** 133003
- [30] Gibbons M J, Hamley C D, Shih C-Y and Chaman M S 2011 *Phys. Rev. Lett.* **106** 133002
- [31] Kwon M, Ebert M F, Walker T G and Saffman M 2017 *Phys. Rev. Lett.* **119** 180504
- [32] Martinez-Dorantes M, Alt W, Gallego J, Ghosh S, Ratschbacher L, Völzke Y and Meschede D 2017 *Phys. Rev. Lett.* **119** 180503
- [33] Andersen M F, Kaplan A and Davidson N 2003 *Phys. Rev. Lett.* **90** 023001
- [34] Andersen M F, Kaplan A, Grünzweig T and Davidson N 2004 *Phys. Rev. A* **70** 013405
- [35] Rosenfeld W, Volz J, Weber M and Weinfurter H 2011 *Phys. Rev. A* **84** 022343
- [36] Yavuz D D, Kulatunga P B, Urban E, Johnson T A, Proite N, Henage T, Walker T G and Saffman M 2006 *Phys. Rev. Lett.* **96** 063001
- [37] Jones M P A, Beugnon J, Gaëtan A, Zhang J, Messin G, Browaeys A and Grangier P 2007 *Phys. Rev. A* **75** 040301

Q2